



nova

5285

Parts Breakdown
*For models: 5285S, 5285SE, 5286S, 5286SE
Serial # Starting "YH"*



CARE • QUALITY • INNOVATION




THE NOVA PROMISE

Revised on July 12, 2023

CONTACT US!
We're here to help

 info@novajoy.com

 1 800 557 6682

novajoy.com

An important note from



Many parts listed and/or pictured on this breakdown may appear to be identical to the part(s) required but may actually be different, due to slight dimensional changes.

Please verify that the serial number on your wheelchair corresponds with the serial number series denoted in the below parts list. The serial number is located on a sticker that is attached to the frame near the front wheel (see Figure 1).

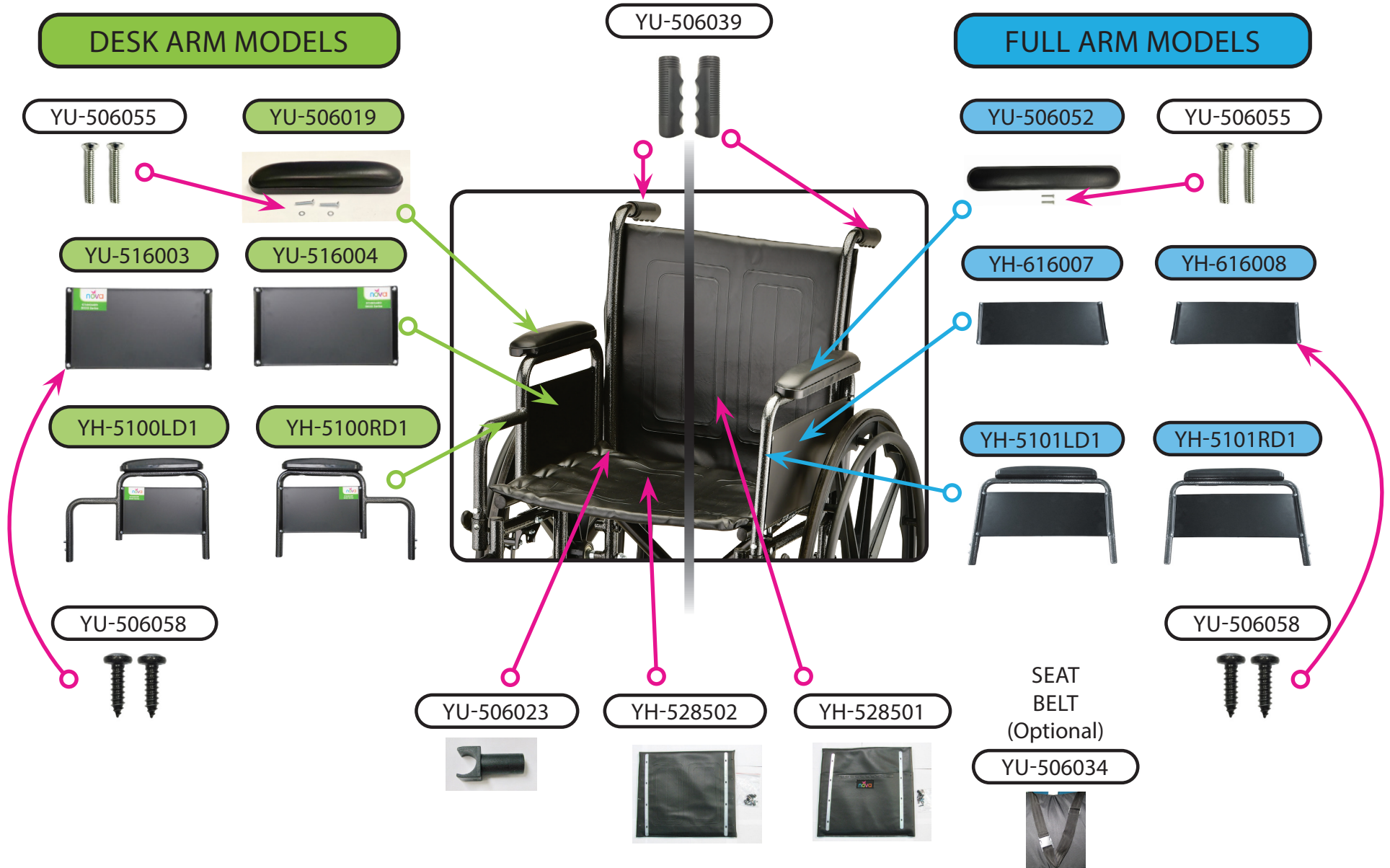
If you need further assistance, please call our customer service team at (800) 557-6682.

Thank you!

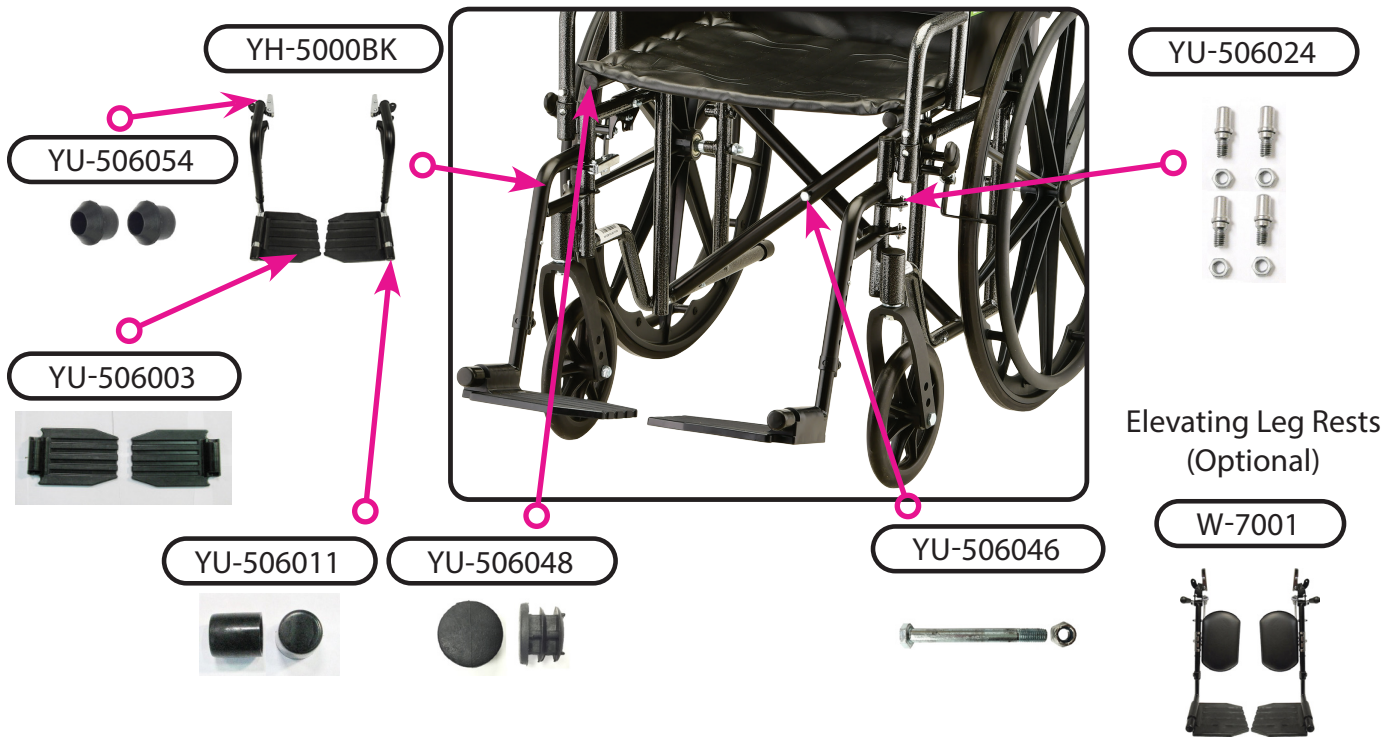


Figure 1

Main Body Components

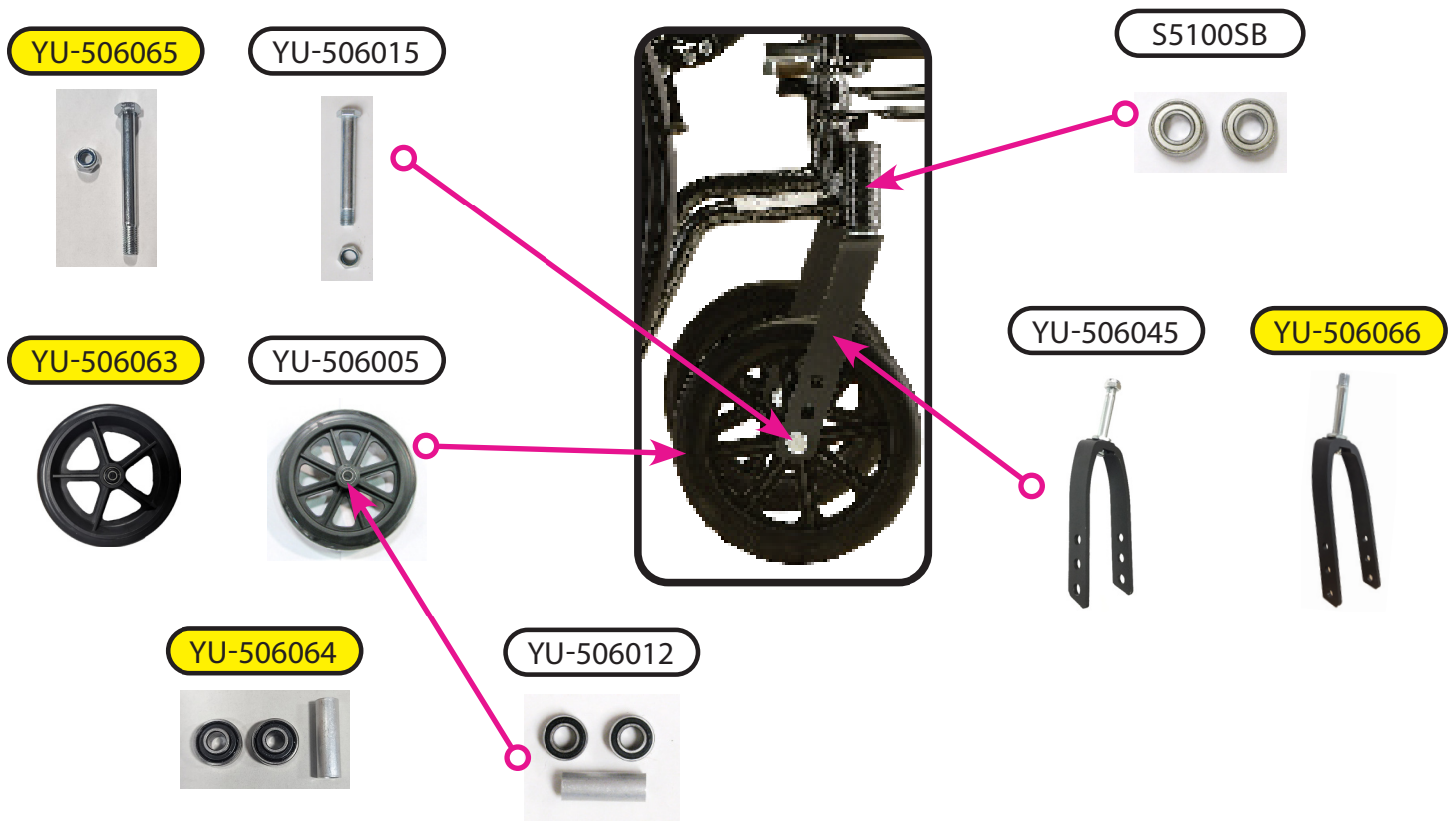


Footrest & Lower Frame Components

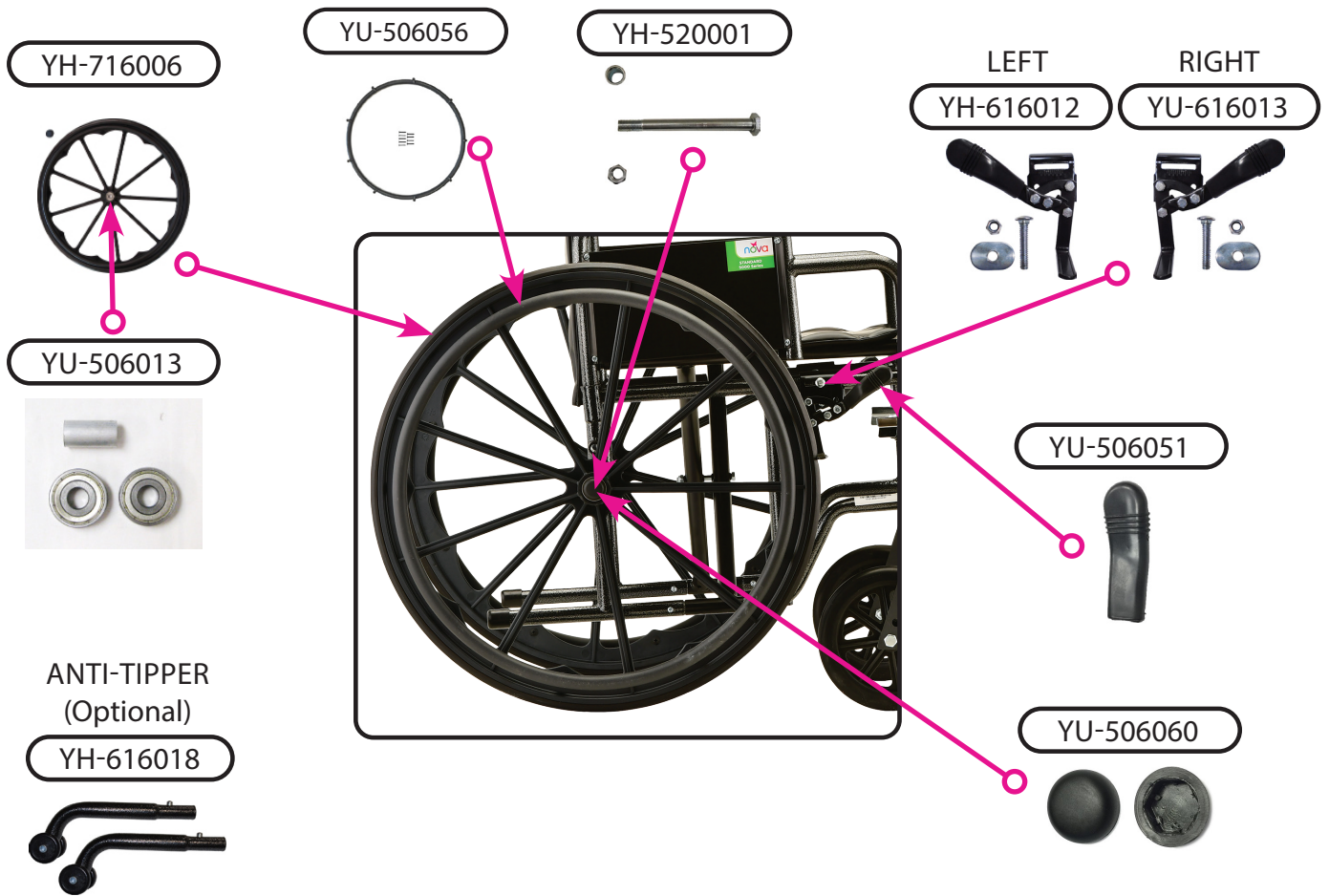



Front Wheel Assembly

SEE SERIAL NUMBER REFERENCE AT THE BOTTOM



Rear Wheel Assembly



	Item Number 5285S/5285SE/5286S/5286SE	
	5285 Steel Wheelchair	
	SERIAL # BEGINNING WITH "YH"	
ITEM NUMBER	DESCRIPTION	UOM
YH-616018	ANTI-TIPPERS	PAIR
YU-506019	ARM PAD DESK ARM WITH SCREWS	EACH
YU-506052	ARM PAD FULL LENGTH WITH SCREW	EACH
YH-520001	AXLE REAR	EACH
YU-506015	AXLE SET FOR 8" WHEEL	SET
YU-506013	BEARING & SPACER SET FOR 24" W	SET
YU-506012	BEARING & SPACER SET FOR 8" WHEEL	SET
YH-616012	BRAKE LEFT	EACH
YH-616013	BRAKE RIGHT	EACH
YU-506011	CAP FOR FOOTREST (PAIR)	PAIR
YH-5100LD1	DESK ARM LEFT	EACH



Item Number 5285S/5285SE/5286S/5286SE

5285 Steel Wheelchair

SERIAL # BEGINNING WITH "YH"

ITEM NUMBER	DESCRIPTION	UOM
YH-5100RD1	DESK ARM RIGHT	EACH
W-7001	ELEVATING LEG RESTS	PAIR
YU-506003	FOOT PLATE (PAIR)	PAIR
YH-5000BK	FOOTRESTS BLACK	PAIR
YU-506045	FORK FOR FRONT WHEEL	EACH
YH-5101LD1	FULL ARM LEFT	EACH
YH-5101RD1	FULL ARM RIGHT	EACH
YU-506039	GRIP (PAIR)	PAIR
YU-506056	HAND RIM FOR 24" WHEEL	EACH
YU-506060	HUB CAP FOR 24" WHEEL	PAIR
YU-516003	PANEL LEFT FOR DESK	EACH
YU-516004	PANEL RIGHT FOR DESK	EACH
YH-616007	PANEL LEFT FOR FULL ARM	EACH
YH-616008	PANEL RIGHT FOR FULL ARM	EACH
YU-506054	PLUG (PAIR) FOR FOOT REST	PAIR
YU-506048	PLUG (PAIR) FOR FRAME	PAIR
YU-506024	PIN (4PCS) FOR FOOTREST	SET
YU-506046	SCREW CENTER FOR CROSSBAR	EACH
YU-506055	SCREW FOR ARM PAD	PAIR
YU-506058	SCREW FOR PANEL/SKIRT GUARD	PAIR
YU-506034	SEAT BELT	EACH
YU-506023	SEAT GLIDE	EACH
S5100SB	SWIVEL BEARING (PAIR)	PAIR
YU-506051	TIP FOR BRAKE	EACH
YH-528501	UPHOLSTERY BACK	EACH
YH-528502	UPHOLSTERY SEAT	EACH
YU-506005	WHEEL 8" FRONT	EACH
YH-716006	WHEEL REAR WITH CAP	EACH

SERIAL NUMBER FOR REFERENCE	
5285S	SN STARTING FROM: YH5285SNN0144

ITEM NUMBER	DESCRIPTION	UOM
YU-506065	AXLE SET FOR 8" WHEEL	SET
YU-506064	BEARING & SPACER SET FOR 8" WHEEL	SET
YU-506066	FORK FOR FRONT WHEEL	EACH
YU-506063	WHEEL 8" FRONT	EACH

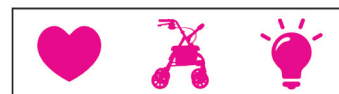
CONTACT US!
We're here to help

 info@novajoy.com

 1 800 557 6682

novajoy.com

CARE • QUALITY • INNOVATION



THE NOVA PROMISE